

Autonics

Photoelectric Sensor BMS SERIES

INSTRUCTION MANUAL



Thank you for choosing our Autonics product.
Please read the following safety considerations before use.

■ Safety Considerations

- ⚠ Please observe all safety considerations for safe and proper product operation to avoid hazards.
- ⚠ symbol represents caution due to special circumstances in which hazards may occur.
- Warning** Failure to follow these instructions may result in serious injury or death.
- Caution** Failure to follow these instructions may result in personal injury or product damage.
- Warning**
 - Fail-safe device must be installed when using the unit with machinery that may cause serious injury or substantial economic loss. (e.g. nuclear power control, medical equipment, ships, vehicles, railways, aircraft, combustion apparatus, safety equipment, crime/disaster prevention devices, etc.) Failure to follow this instruction may result in personal injury, economic loss or fire.
 - Do not use the unit in the place where flammable/explosive/corrosive gas, high humidity, direct sunlight, radiant heat, vibration, impact, or salinity may be present. Failure to follow this instruction may result in explosion or fire.
 - Do not disassemble or modify the unit. Failure to follow this instruction may result in fire.
 - Do not connect, repair, or inspect the unit while connected to a power source. Failure to follow this instruction may result in fire.
 - Check 'Connections' before wiring. Failure to follow this instruction may result in fire.

⚠ Caution

- Use the unit within the rated specifications. Failure to follow this instruction may result in fire or product damage.
- Use dry cloth to clean the unit, and do not use water or organic solvent. Failure to follow this instruction may result in fire.

■ Ordering Information

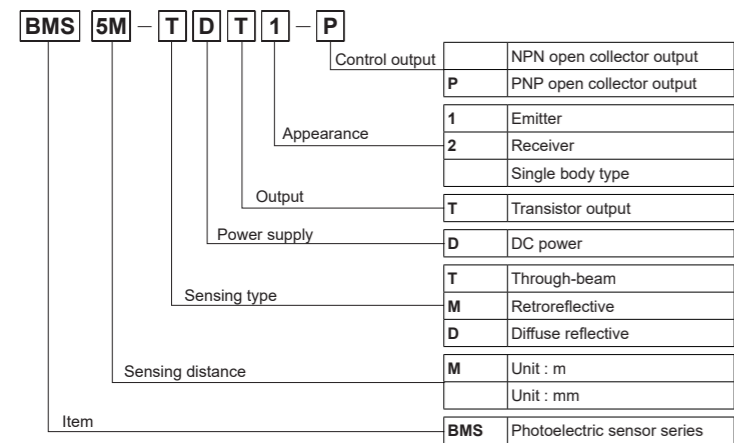

■ Operation Mode

Operation mode	Light ON	Dark ON
Receiver	Received light Interrupted light	
Operation indicator (red LED)	ON OFF	
Transistor output	ON OFF	

Note) The Transistor output will be maintained OFF for 0.5 sec. after supplied power in order to prevent malfunction of this photoelectric sensor.

⚠ The above specifications are subject to change and some models may be discontinued without notice.
⚠ Be sure to follow cautions written in the instruction manual and the technical descriptions (catalog, homepage).

■ Specifications

Type	Through-beam	Retroreflective ^{※1}	Diffuse reflective
Model	NPN open collector output PNP open collector output	BMS5M-TDT BMS5M-TDT-P	BMS2M-MDT BMS2M-MDT-P
Sensing distance	5m	0.1 to 2m	300mm (100×100mm non-glossy white paper)
Sensing target	Opaque materials of min. ø10mm	Opaque materials of min. ø60mm	Translucent, opaque materials
Hysteresis	—	—	Max. 20% at sensing distance
Response time	Max. 1ms	—	—
Power supply	12-24VDC±10% (ripple P-P: max. 10%)		
Current consumption	Max. 50mA	Max. 45mA	—
Light source	Infrared LED (940nm)		
Sensitivity adjustment	—	Sensitivity adjuster	
Operation mode	Selectable Light ON / Dark ON by control wire		
Control output	NPN or PNP open collector output • Load voltage: max. 30VDC± • Load current: max. 200mA • Residual voltage - NPN: max. 1VDC±, PNP: max. 2.5VDC		
Protecting circuit	Reverse polarity protection, Short-circuit protection		
Indication	• Operation indicator: red LED • Power indicator: red LED (BMS5M-TDT1)		
Insulation resistance	Over 20MΩ (at 500VDC megger)		
Noise immunity	±240V the square wave noise (pulse width: 1μs) by the noise simulator		
Dielectric strength	1000VAC 50/60Hz for 1minute		
Vibration	1.5mm amplitude at frequency of 10 to 55Hz in each of X, Y, Z directions for 2 hours		
Shock	500m/s ² (50G) in X, Y, Z directions for 3 times		
Environment	Ambient illumination	Sunlight: max. 11,000lx, incandescent lamp: max. 3,000lx (receiver illumination)	
	Ambient temperature	-10 to 60°C, storage : -25 to 70°C	
	Ambient humidity	35 to 85%RH, storage: 35 to 85%RH	
Material	Case: ABS, Sensing part: Acryl (Through-beam: PC)		
Cable	ø5mm, 4-wire, length: 2m (emitter of through-beam type: ø5mm, 2-wire, length: 2m) (AWG22, core diameter: 0.08mm, number of cores: 60, insulator diameter: ø1.25mm)		
Accessories	Individual	—	Reflector(MS-2), adjustment screwdriver
	Common	Mounting bracket, M4 bolt: 4, M4 nut: 4	Mounting bracket, M4 bolt: 2, M4 nut: 2, adjustment screwdriver
Approval	CE		
Unit weight	Approx. 180g	Approx. 110g	Approx. 100g

※1: The sensing range and the sensing object of the retroreflective sensor are specified with using the MS-2 reflector. The sensing ranges of the retroreflective sensor in the above table are identified as the possible setting ranges of the MS-2 reflector. The sensor can detect an object under 0.1m apart.
※ The temperature or humidity mentioned in Environment indicates a non freezing or condensation environment.

■ Connections

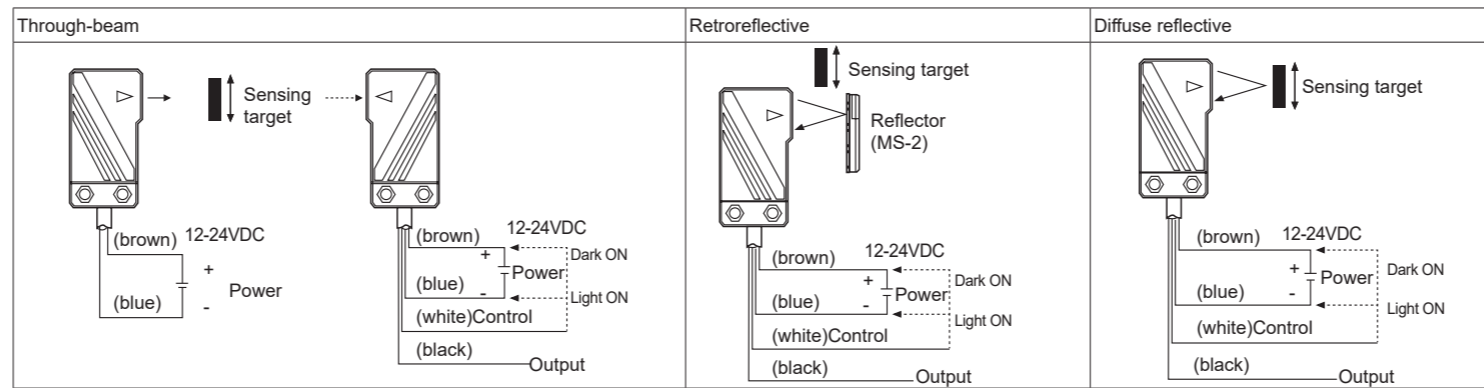

■ Dimension

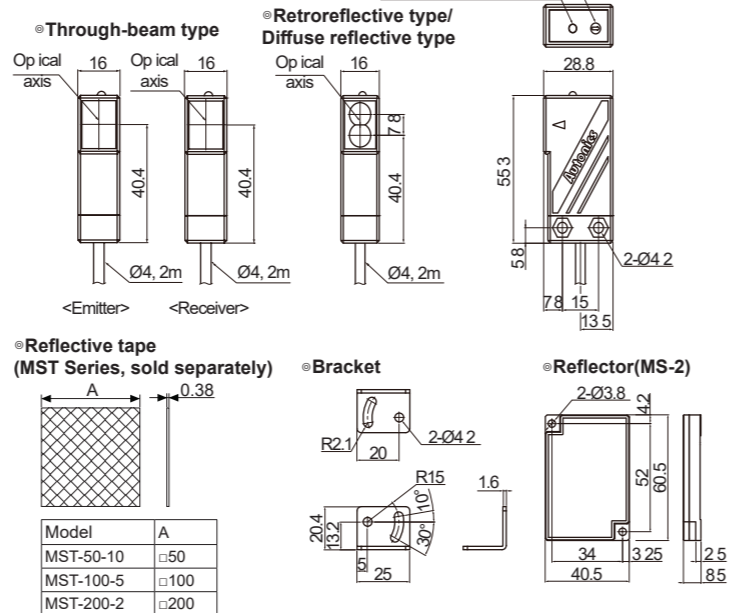

■ Control Output Circuit Diagram

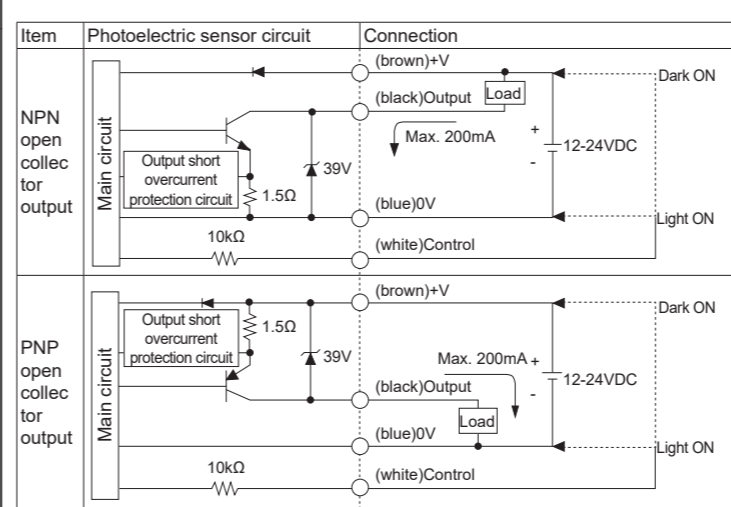

⚠ If short-circuit the control output terminal or supply current over the rated specification, normal control signal is not output due to the output short over current protection circuit.

■ Mounting and Sensitivity Adjustment

Please supply the power to the sensor, after setting the emitter and the receiver in face to face, and then adjust an optical axis and the sensitivity as follow.
When using photoelectric sensors closely over two units, it may result in malfunction due to mutual interference.
When installing the product, tighten the screw with a tightening torque of 0.8N·m.

● Optical axis adjustment

- Through-beam type**
Set the photoelectric sensor in the middle of receiver indicator turns on, as adjusting the receiver or emitter right and left, up and down.
- Retroreflective type**
Mount the photoelectric sensor and mirror face to face then fix them in the middle of operation indicator turns on, as adjusting the mirror right and left, up and down
- Diffuse reflective type**
Mount the photoelectric sensor and the target then fix it in the middle of operation indicator turns on, as adjusting the photoelectric sensor right and left, up and down.

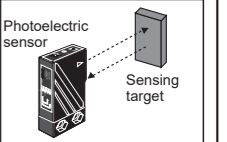
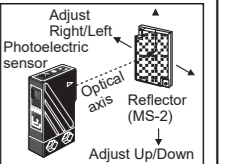
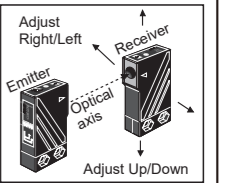

● Sensitivity adjustment

- Retroreflective type**
Fix the adjuster at max. position and then check if the sensor operates normally or not, as passing the target within detecting range of the sensor. If the sensor does not work normally by noise or external shine, turn the adjuster slowly at position where the sensor works normally.
※ If reflectance of target is higher than non-glossy white paper, it might cause malfunction by reflection from the target when the target is near to photoelectric sensor. Therefore put enough space between the target and photoelectric sensor or the surface of target should be installed at an angle of 30° to 45° against optical axis.

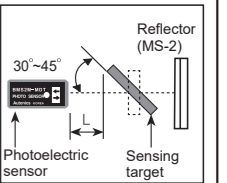

2. Diffuse reflective type

- Set the target at a position to be detected by the beam, then turn the adjuster till point ① which the indicator turns on from min. Take the target out of the sensor, then turn the adjuster till point ② which the indicator turns on, if it does not turn on, max. sensitivity position will be point ③. Set the adjuster in middle of two switching point ①, ②.
※ Please be aware not to make the unstable operation of sensor by background and mounting side.

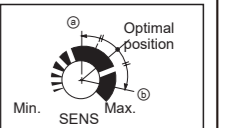

■ Cautions during Use

- Follow instructions in 'Cautions during Use'. Otherwise, it may cause unexpected accidents.
- When connecting a DC relay or other inductive load to the output, remove surge by using diodes or varistors.
- Use the product, 0.5 sec after supplying power. When using separate power supply for the sensor and load, supply power to sensor first.
- 12-24VDC power supply should be insulated and limited voltage/current or Class 2, SELV power supply device.
- Wire as short as possible and keep away from high voltage lines or power lines, to prevent inductive noise.
- When using switching mode power supply to supply the power, ground F.G. terminal and connect a condenser between 0V and F.G. terminal to remove noise.
- When using sensor with the equipment which generates noise (switching regulator, inverter, servo motor, etc.), ground F.G. terminal of the equipment.
- This unit may be used in the following environments.
 - ① Indoors (in the environment condition rated in 'Specifications')
 - ② Altitude max. 2,000m
 - ③ Pollution degree 3
 - ④ Installation category II

■ Major Products

- Photoelectric Sensors
- Fiber Optic Sensors
- Door Sensors
- Door Side Sensors
- Area Sensors
- Proximity Sensors
- Pressure Sensors
- Rotary Encoders
- Connectors/Sockets
- Switching Mode Power Supplies
- Control Switches/Lamps/Buzzers
- I/O Terminal Blocks & Cables
- Stepper Motors/Drivers/Motion Controllers
- Graphic/Logic Panels
- Field Network Devices
- Laser Marking System (Fiber, CO₂, Nd: YAG)
- Laser Welding/Cutting System
- Temperature Controllers
- Temperature/Humidity Transducers
- SSRs/Power Controllers
- Counters
- Timers
- Panel Meters
- Tachometer/Pulse (Rate) Meters
- Display Units
- Sensor Controllers